





## EZ SERIES: EZ7

<http://tiny.cc/EZ7seriesEN>

 MAX LIFTING CAPACITY <b>1650</b> kg	 BATTERY CAPACITY <b>16,5</b> kWh	 SPEED <b>12</b> km/h	 FLOW RATE <b>35</b> l/min	 LIFT HEIGHT <b>2,9</b> m
--	---	---	--	---

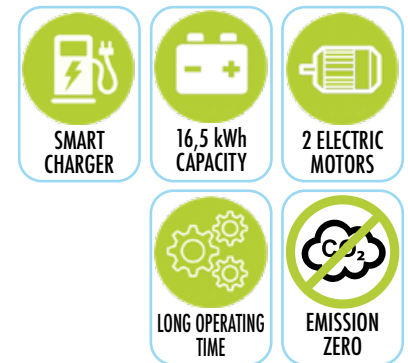
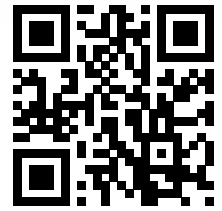

Model	EZ 7
Transmission	Hydrostatic
Drive speed (max.) <sup>(1)</sup>	12 km/h (7.5 mph)
Aux. hydraulics oil flow	35 l/min (9.3 GPM)
Max. lifting height	2,90 m (114 in)
Tipping load, max. <sup>(2)</sup>	2070 kg (4563 lbs)
Lifting capacity straight, max. <sup>(3)</sup>	1650 kg (3637 lbs)
Breakout force / 50 cm	1700 kg (3748 lbs)
Pushing force (c)	2050 kgf (2050 kp)
Average ground pressure (w/standard tires)	1135 kg/m <sup>2</sup> (232 lbs/sqft)
Turning radius: inside/outside	825/2090 mm (32.5/82.3 in)
Standard tires (Tractor profile)	26X12.00-12
Weight	1860 kg (4110 lbs)
Product Code	C962020

## Electric system and battery

Battery type	Lead Acid
Battery capacity	16,5 kWh
Electric motors	2
Charging system	Integrated charger
Charger type	Sealed single-phase
Charger Input Voltage	110 - 230 ± 10% VAC
Charger Input Frequency	50 ÷ 60 Hz
Charger Absorbed Current	Max. 14 A
Charging Current (230 VAC)	Max. 60 A
Charging Current (120 VAC)	Max. 30 A
Charger plug type	Schuko, CEE 7/7
Charger Protection	Output short-circuit, Inverse polarity
Charger Operating temp.	- 30° to + 70° C

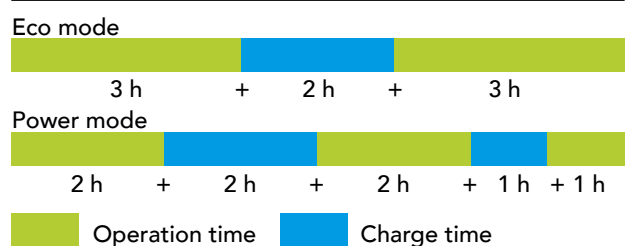
Daily work cycle in hours <sup>(4)</sup>

<sup>(1)</sup> Maximum speed that can be achieved with the largest diameter tires available, on a flat surface and machine without attachments.

<sup>(2)</sup> Tipping limit, when the machine is straight, with rear weights and boom lifted just off the ground. Weight of attachment included.

<sup>(3)</sup> Maximum load that can be lifted just off the ground when the machine is straight and with rear weights. Weight of attachment is included.

<sup>(4)</sup> The operation time of machine varies highly depending on the type of work it is performing.

Note: Refer to the Operator's manual for the comprehensive load diagram.

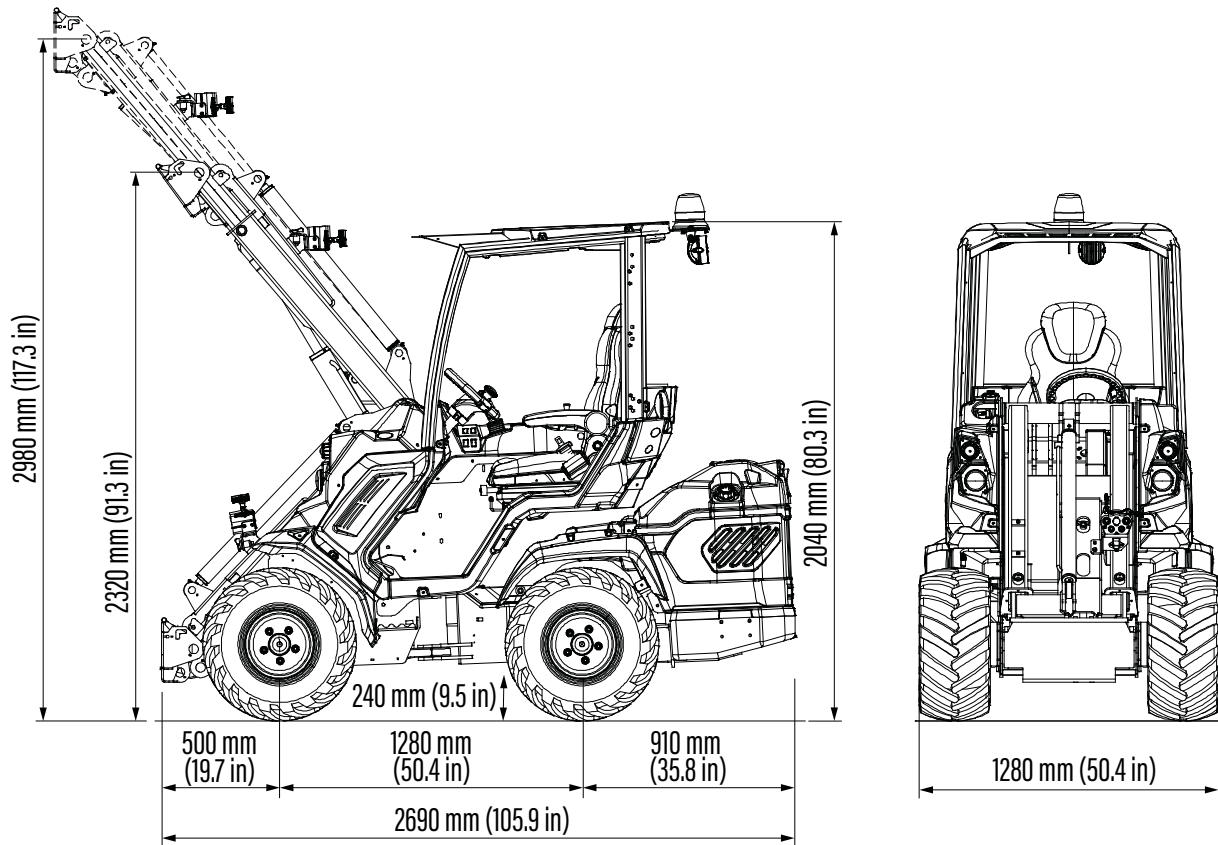

Tires size	Height	Width
23X8.50-12	2020 mm (79.5 in)	1070 mm (42.2 in)
23X10.50-12 ET-25	2020 mm (79.5 in)	1130 mm (44.5 in)
26X12.00-12 ET-50	2040 mm (80.3 in)	1280 mm (50.4 in)
27X8.50-15	2080 mm (81.9 in)	1070 mm (42.1 in)
27X10.50-15	2080 mm (81.9 in)	1150 mm (45.3 in)

## FEATURES

- Twin Motors Single Ended Circuits
- Lead Acid Battery
- Integrated Smart Battery Charger
- Zero Emission
- Low Noise
- Braking Energy Recovery System
- 4WD hydrostatic Direct Drive motors, proportional servo control
- DBS (Dynamic Block System)
- Self-levelling double-H telescopic boom
- 4-functions joystick
- Self-locking multi-disk parking brake
- LCD graphic display with programmed service
- 2 front led working light
- Ergonomic full adjustable suspension seat with armrests and seat belt
- Radial piston high efficiency and heavy duty wheel motors
- Hydraulic multiconnector
- ROPS-FOPS Level I